

Installation manual for

2200G36BK

Dimensions : L36" W12"H12" L20

Collection : Serena

Bulb Type : G9 bulb not included

Lamp Frame Weight: 12.5 LBS

Total Weight : 23.2 LBS



Thank you for choosing our product(s).

Our Company is actively involved in every step of the production.

Our product(s) are designed to be utilized for every application that graces your home or business.

We pride ourselves in providing the most prompt and courtesy service to all of the valued customers.

Please find the enclosed detailed instruction and read carefully for proper installation.

If you have any questions, please contact the retailer Where the purchased was made.

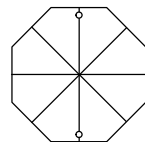

SAFETY

Warning: MAKE SURE THE ELECTRICITY TO THE WIRES YOU ARE WORKING ON IS SHUT OFF. BY EITHER REMOVING THE FUSE OR TURNING OFF THE CIRCUIT BREAKER.

CAUTION

- Before assembling the lighting fixture, please read all instructions carefully.
- All frame & crystal components are fragile, please handle with care.
- Required supply circuit : 110 - 130V/60Hz
- Labeled wires are "L" for live wire, "N" for neutral wire, "E" for ground wire.
- Never install fixture on damp ceiling, the room should be dry and well ventilated
- All electrical components must be installed by a licensed electrician and in accordance with the National Electrical Code and the appropriate local electrical codes.

Unpack the Package

Please open the box carefully and check all the items are inside the box. If you have any installation, assembling and missing parts questions. where you purchase from and any other relevant information ready, our customer service team will provide comprehensive and worry free service to our valued customers.

Frame Assembly Diagram

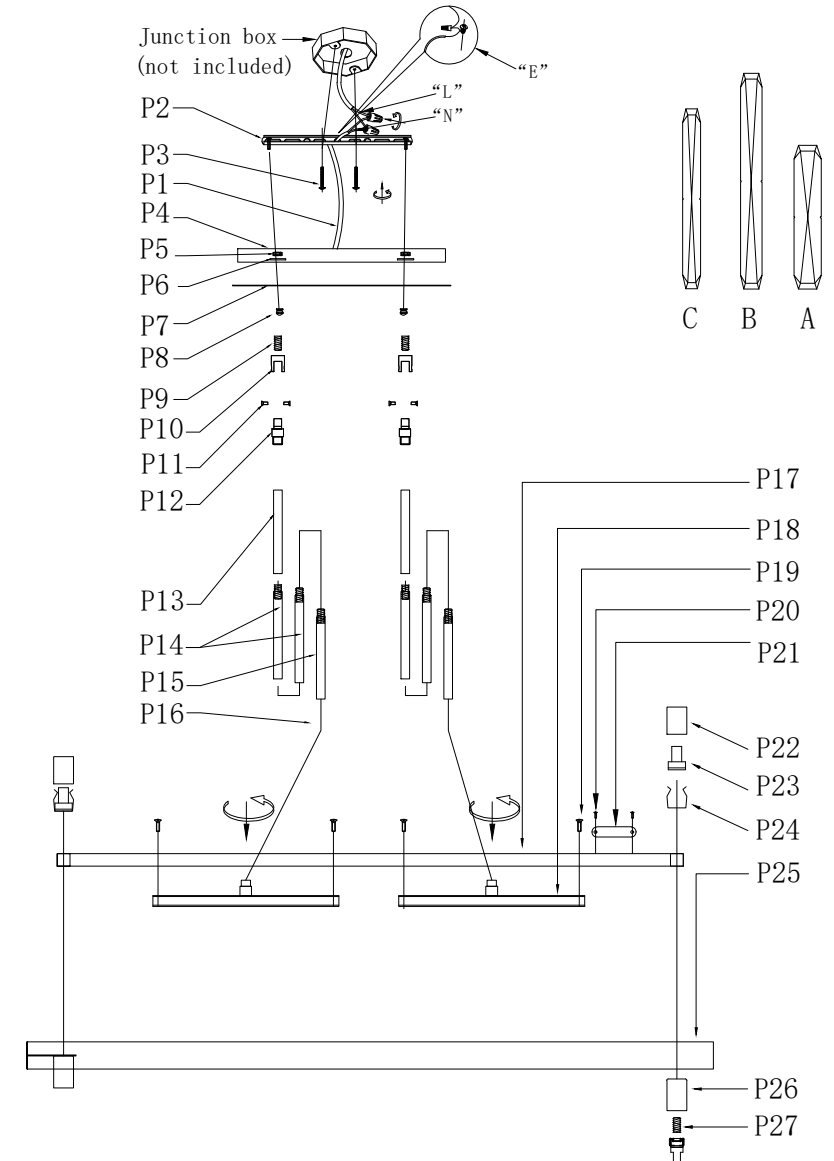











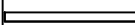

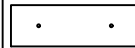
2200G36BK L36" W12" H12" L20





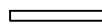
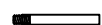





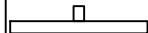

Step 1

Please use the parts list to ensure you are not missing any parts.

PARTS LIST

Part Number	Picture	Description	Qty	Diagram Number	
Cord-75-18#-CL		Power Cord 75" SPT-2 Clear	1	P1	
CP3R07BK		Crossbar 4" (Canopy part)	1	P2	
		5/32-32 Screw	2	P3	
		L15" Canopy plat	1	P4	
		Set nut	2	P5	
		metal washer	2	P6	
		L16" sheetmetal	1	P7	
		NUT	2	P8	
		thread pipe	2	P9	
		NUT	2	P10	
		Screw	4	P11	
		NUT	2	P12	
	ROD9019BK		L16" metal tube (ROD9019)	2	P13
			L12" metal tube (ROD9019)	4	P14
		L6" metal tube (ROD9019)	2	P15	
		thread pipe	2	P16	

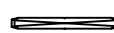
2200G36BK L36" W12" H12" L20

Part Number	Picture	Description	Qty	Diagram Number	
P-2200G36BK-1		Metal frame	1	P17	
		L8" metal tube	2	P18	
		Ground Screw	4	P19	
		Ground Screw	2	P20	
		sheetmetal	4	P21	
		metal tube	10	P22	
		G9 Socket	20	P23	
		G9 circlip	10	P24	
		L36" Metal Body	1	P25	
		G9 Metal lamp cup	10	P26	
		thread pipe	10	P27	
	CR-2200-RC-CL-A		L8" Article crystal	14	A
	CR-2200-RC-CL-B		L11.8" Article crystal	14	B
CR-2200-RC-CL-C		L9.8" Article crystal	14	C	

Step 2

Canopy Installation Instruction

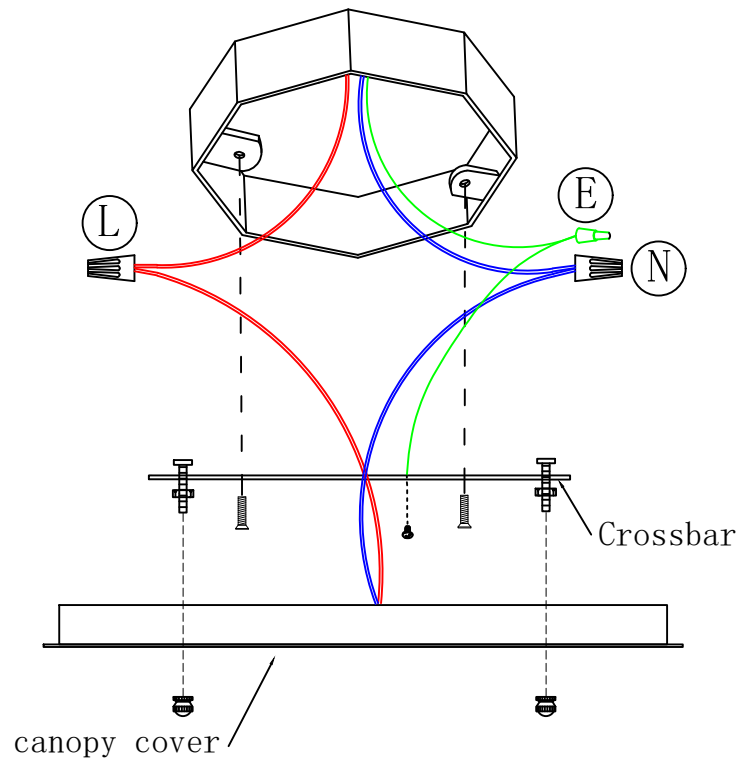

"L"=Hot wire
 "N"=Neutral wire
 "E"=GND

⑤

Important: This product must be installed in accordance with the local installation codes by a person familiar with construction and operation of this product and the hazards involved.

1. Black wire from ceiling(junction box) attaches to "L" wire from the fixture.
2. White wire from ceiling(junction box) attaches to "N" wire from the fixture.
3. "E" wire from the fixture is attached to the mounting bracket and an additional "E" wire from the mounting bracket must be secured to the junction box.
4. Secure mounting bracket to the junction box.
5. Insert screws in side of top unit the mounting bracket.

⑥

Frame Assembly Diagram

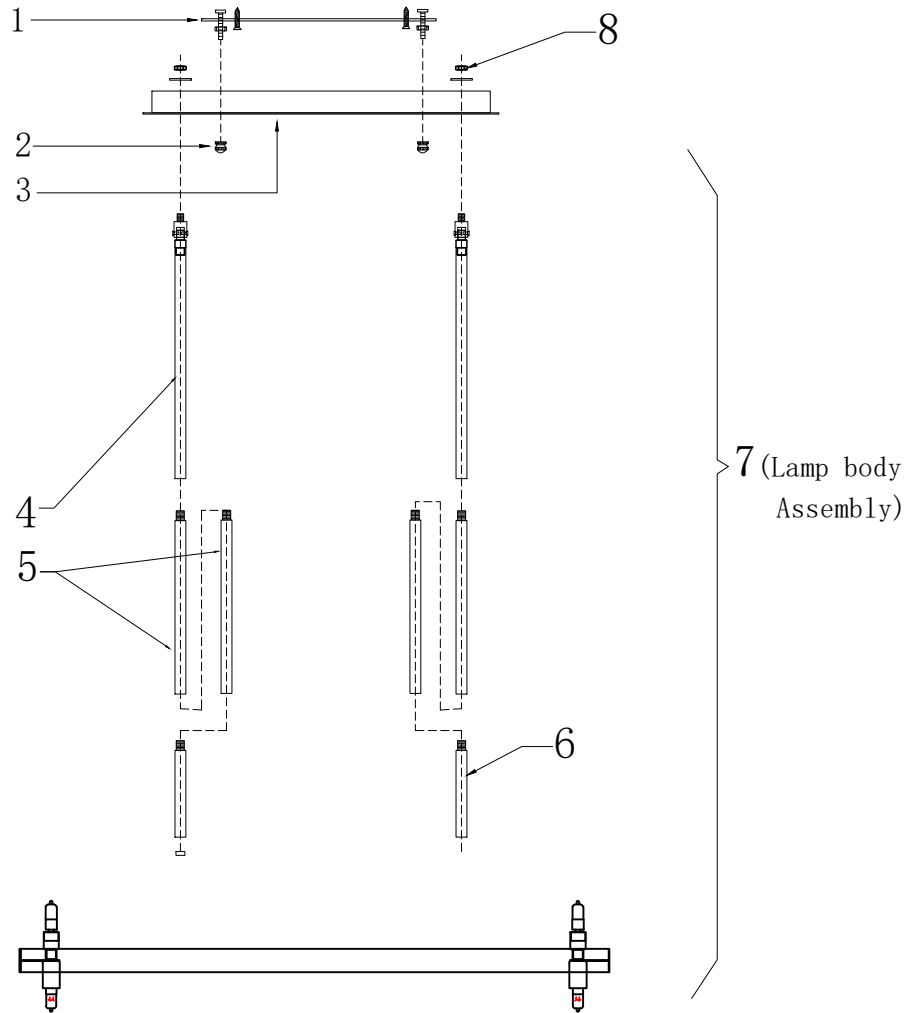

⑦

Step 3

Frame Assembly Instructions

Installation:

Please read all instructions carefully.

Before you proceed to install, make sure that the power supply is turned off and remains off until installation is complete.

Please note that each part has been assigned a number.

Please proceed in a numerical order.

1. Fix the Mounting bracket(1) to the ceiling.
2. First run the power cord through the metal tube(4.5.6).
3. Fix the Metal tube(4.5.6) to the lamp body(7).
4. Fix the Canopy(3) to the Metal tube(4) By the Set nut(8).
5. Fix the Canopy(3) to the mounting bracket(1) with knurled nuts(2).
6. Install the bulb(not included) to the lamp fixture.
7. As the crystal dressing instruction, hang the crystal parts.

The end!

⑧

Step 4 Crystal Dressing Instructions

1. Hang Crystal:A, B, C

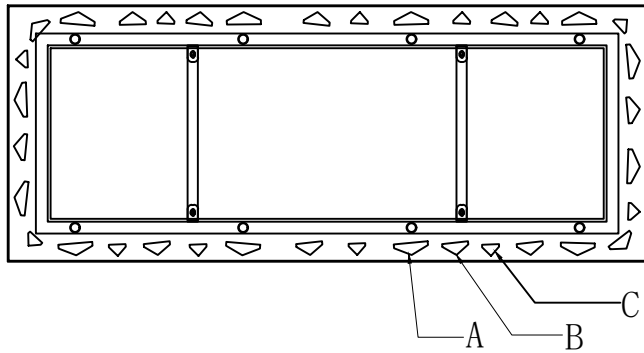

09



When dressing the chandelier with the crystals please remember to wear either rubber or cotton gloves. So as to prevent any damage or smudging on the crystals.

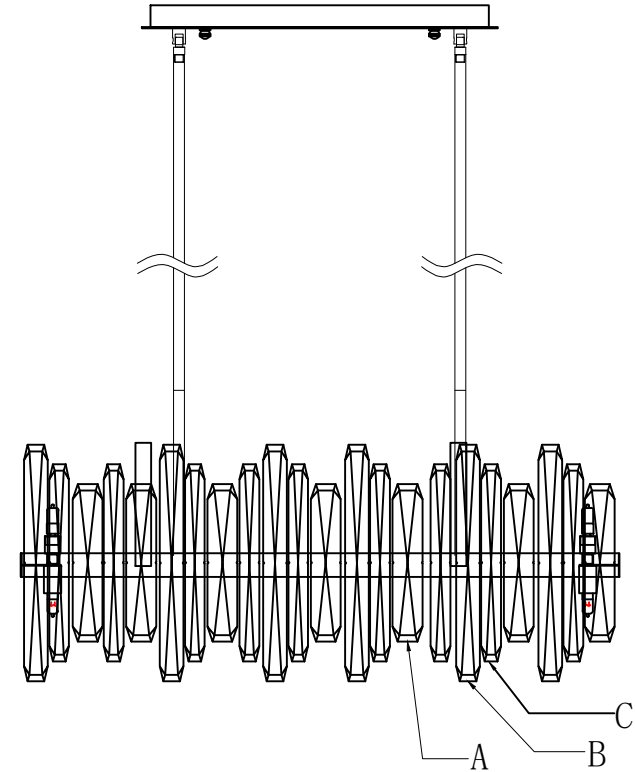

10

Congratulations !

You are now done installing your Elegant Lighting fixture. Sit back and admire each crystal as it will become the statement piece for your room/house.

Thank you.

Cleaning and Maintenance of Chandelier Frame
The finish on our chandelier frames and fixture frames is protected by a durable coating of lacquer. To clean, use a clean soft, dry cloth. Do not use any metal polishes, cleaners, abrasives or any substance which could remove the protective finish. Failure to follow these instructions automatically voids the guarantee.

Cleaning and Maintenance of Crystals
Wet a soft cotton fabric in clean warm water and wipe gently, then polish with a dry soft cotton fabric.

To Order Crystal Replacement Parts
Should you require replacement crystals or pins (the metal connectors attaching the crystals), contact the store where the product was purchased or contact us . For ease of ordering, you may use the original crystal trimming instructions provided with this product and circle the items you wish to order, indicating the quantity by writing the number needed adjacent to the circle . You will be contacted with prices prior to shipment. All orders must be pre-paid.

Elegant Lighting Warranty

The finish and frame of your new chandelier or fixture are warranted for a period of one (1) year from the date of purchase. Our company will, at its option, repair or replace any frame that has a defect in the materials or workmanship during the warranty period. All crystals are guaranteed for their original quality during the life of the chandelier. Breakage is not covered by this warranty.

To make a claim under this warranty, contact our customer service department.

A written return authorization form will be sent to you with specific instructions.

Returns and Conditions of Warranty

Returns must be pre-authorized by contacting our customer service department. Returns will only be accepted with a written return merchandise authorization and return shipping charges pre-paid. We reserve the right to inspect all returned merchandise to fully determine the nature of any defect. This guarantee shall not apply to any product that has been changed, altered or otherwise modified, nor shall it apply to any product that has been repaired or altered by anyone other than a pre-authorized facility. We will not be responsible for any breakage or damages incurred during transit, nor for crystal parts or metal frame part that have been subject to misuse, negligence, accident or inappropriate handling. Also, we will not be held responsible for damage incurred during improper installation or wiring by others, nor for damages resulting from a failure to follow the recommended maintenance or installation procedures. This guarantee is issued in lieu of any and all other guaranteed or warranty, whether written or implied and any and all other obligations or liabilities. Further, we neither authorize nor permit any other person or firm to assume for us, any liability in connection with the sale of our products.